

# EASY CONNECT® INSTALLATION INSTRUCTIONS

IOL310  
IOL311  
09/16

QUESTIONS OR CONCERNS CONTACT AT:

1-800-265-1833 (English) / 1-800-567-2513 (French) Monday through Friday 8:00 AM to 5:00 PM E.S.T.



## SAFETY PRECAUTIONS:

1. TURN OFF ELECTRICAL POWER BEFORE STARTING INSTALLATION OF LIGHT FIXTURE.
2. WIRING SUPPLIES AS REQUIRED BY LOCAL ELECTRICAL CODE.
3. THIS PRODUCT MUST BE INSTALLED IN ACCORDANCE WITH THE APPLICABLE INSTALLATION CODE BY A PERSON FAMILIAR WITH THE CONSTRUCTION AND OPERATION OF THE PRODUCT AND THE HAZARDS INVOLVED.
4. TO CLEAN THE FIXTURE, TURN OFF THE POWER, WAIT FOR IT TO COOL, AND WIPE THE FIXTURE WITH A CLEAN, SOFT CLOTH.

**NOTE:** Product may not look exactly as shown in figures.

## INSTALLATION:

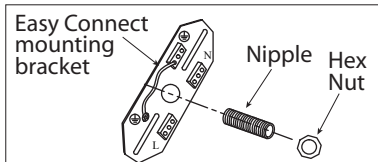

1. Attach nipple to mounting bracket. Adjust so it will clear hole in back of fixture and then lock nipple in place with hex nut.

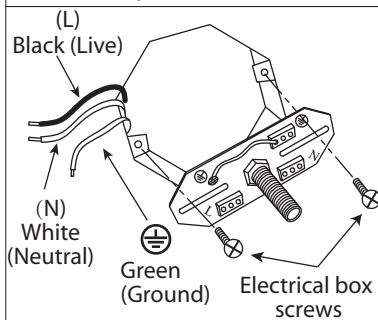

2. Attach mounting bracket to electrical box with electrical box screws (not included).

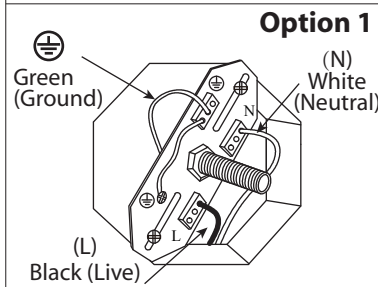

3. **Option 1:** Connect (push) electrical wires from electric box (house wiring) into correct inserts.

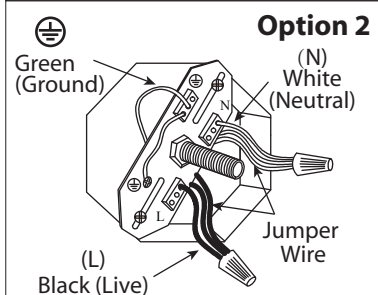

3. **Option 2:** For multiple black (live) & white (neutral) wires joined in the electrical box (house wiring), attach a single "black" and "white" Jumper Wire before connecting. Strip 7mm from a 6" Jumper Wires (AWG 12-24) supplied. Then connect (push) wires into correct inserts.

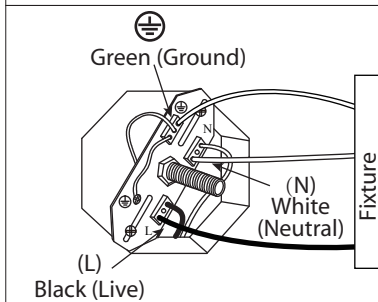

4. Connect (push) electrical wires from fixture into correct inserts.

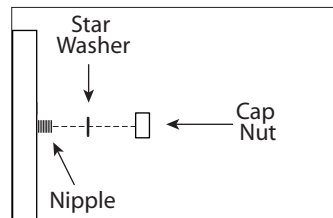

5. Once connections of wires are completed, carefully tuck wires and wire nuts into the electrical box making sure no bare wire (on the black and white) is visible at the wire nuts. Position hole in fixture over nipple and secure in place with star washer and cap nut.

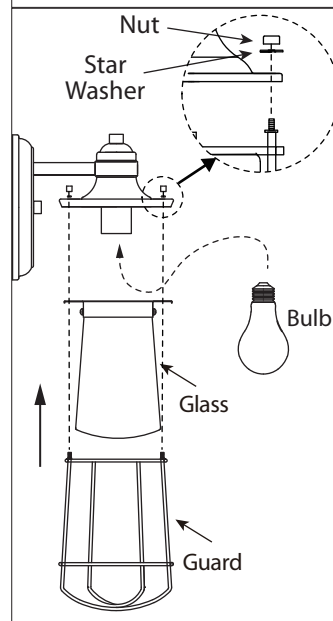

6. Install proper bulb type and wattage (not included).

7. Install the glass and guard with the star washers and nuts.

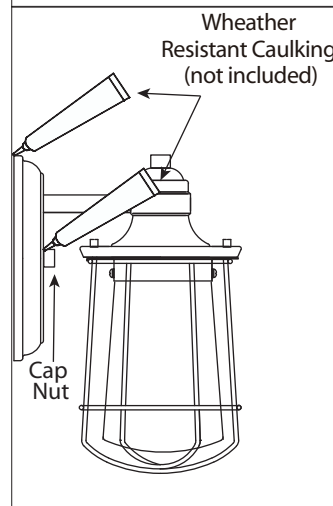

8. After installation, seal around the top and side perimeter between the fixture and the wall surface with weather resistant caulking. The bottom should be left un-caulked to prevent moisture build-up. Apply a small amount of weather resistant caulking around the side perimeter between the cap nut and mounting plate.